



Oriental Education Society's

ORIENTAL COLLEGE OF LAW

(Affiliated to Mumbai University-Approved by Bar Council of India)



PRESENTS

VAKALAT



LAW & JUSTICE

STATE LEVEL MOOT COURT (2023-24)



Late Prof. Javed Khan-

“To develop every single student to grow to be self motivated, independent, confident leaders for the future infused with values of integrity, politeness, kindness and respect for each individual irrespective of their status or position”

Mrs. Humera J. Khan President's Message-



We are delighted to have students from diverse backgrounds. Students are nurtured to develop team work skills, to communicate effectively, have fluency in speaking and cultivate professional attitude in them.



Mr. Waseem J. Khan General Secretary-

Our aspiration is to provide students with excellent professional opportunities in conjunction with congenial atmosphere where they can hone their communication skill, leadership qualities, self discipline and their passions.

Dr. Haider-E-Karrar CEO-



Oriental Education Society (OES) has been operating persistently towards providing top quality education to students with the purpose of equipping them for a distinguished global career



Mrs. Rupali S Jamode Principal-

To create a world class individuals with excellence in personal and professional fields, with the devotion to inculcate competency of highest standards.

Mr. Ranjeev Joseph Faculty Incharge-



I encourage all of you to actively participate, share your ideas, and collaborate with your fellow committee members. Together, we can create a supportive and inspiring environment for learning and growth

Adv. Vinit Pareek Chairperson-



Wishing all the prospect advocates participating, to explore Advocacy and be an eminent personality in court as well as life

Adv. Shreedeeep Sharma Co-Chairperson

I express my heart-felt warm wishes to all young students to excel as sky is the limit



Adv. Vivek Tiwari Co-Chairperson



I impact strongly to all my fellow upcoming advocates to have the mindset of a Senior Counsel in order to be one

ORIENTAL COLLEGE OF LAW

Presents

VAKALAT

INTER COLLEGE MOOT COURT COMPETITION

2023

1. ADMINISTRATION AND GENERAL RULES

The name of the Competition is ORIENTAL COLLEGE OF LAW Presents VAKALAT : INTER COLLEGE MOOT COURT COMPETITION 2023

2. IMPLEMENTATION AND INTERPRETATION OF THE RULES

Rules and Procedures contained in this document shall apply to all participating teams. Regarding the practice and procedure of the Competition, the final interpretation in case of any conflict lies with the Moot Court Association (“MCA”). The decision of the MCA shall be final and binding on all. The rules of the Moot Court shall be strictly adhered to. Any deviation therein would attract disqualification or other penalties as decided by the Organizers.

3. ELIGIBILITY:

1. Students pursuing their bachelor's degree in the current calendar year in a three-year or five-year course in law from any recognized school/ college/ university are eligible to participate in the competition.
2. The first 20 teams will be allowed to participate on first-come-first-serve basis.
3. Team members must be bonafide students of the University they are representing. Once registered (Final registration), a team will not be permitted to vary their composition in any manner.

4. OFFICIAL LANGUAGE:

The official language for the Competition shall be English, Hindi and Marathi only as per the rules of trial courts.

5. DATE AND VENUE OF THE COMPETITION:

Date: 26th to 28th October, 2023.

Venue: The Oriental College of Law, Plot No 3, 4, 5, Sector 2, Sanpada, Navi Mumbai, Maharashtra 400705

6. TEAM COMPOSITION:

1. The participating team shall comprise of :-

MINIMUM THREE (3) - MAXIMUM FOUR (4) MEMBERS.

2. In a team two (2) members under compulsion shall be designated as 'SPEAKERS', the remainder members shall have the liberty to enact/ represent themselves as the Prosecution witnesses.

3. The remainder members other than the speakers representing as witnesses may have the liberty to perform in any formation (i.e. one member may do all roles of witness or may split up amicably as per their convenience.) *Note- SPEAKERS SHALL NOT BE

WITNESSES

4. Once registered, a team will not be permitted to vary the composition of the team in any manner. Changes, if any, may only be made with the express permission of the MCA.

5. No additional/observer member shall be entitled to hospitality or certificate.

6. The Organizing Committee reserves the Right to bar any team from participating in the Competition

7. REGISTRATION PROCESS:

1. Each institution must, first, provisionally register itself for the Competition by sending a mail with the registration form attached herewith. Once the confirmation is approved they can proceed further for the payment and online registration

2. The Online Registration link will be shared alongwith the approval mail

3. Participants will receive an acknowledgement-cum-approval as a confirmation of their registration.

4. **Teams are required to complete their**

Registration by 20th October, 2023 by 23:59 IST.

5. The Registration Fee is **Rs.2000/-** which shall be payable through Online Transition Mode (Non-Refundable) and shall be made in favor of the Oriental College of Law.

6. Stay shall be provided free of cost for outstation students only (outside Mumbai and Navi-Mumbai)

Payment Details:

Account holder name	Oriental College of Law
Account number	103403130002881
IFSC code	SVCB00000034
Bank name	SVC CO-OPERATIVE BANK LTD
Branch	Sanpada (East)

a) Bearing Subject as “PARTICIPATING TEAM’S COLLEGE NAME” e.g. (Subject: Oriental College of law, Sanpada) followed by Approval of their Moot Court Faculty Coordinator/Dean/Principle with the details of the participating team along with screenshot of fee receipt.

b) The Registration shall be deemed complete only when the Online Registration form is duly filled, Email Approval is received and the Registration fee is paid. The teams must send the Screenshot of their Online Transaction Fee through email to email id oclmootcourt@gmail.com and the teams shall receive the confirmation of their provisional Registration from Oriental College of Law Moot Court Association within 2-3 days.

IDENTIFICATION OF PARTICIPATING TEAM

The Team Codes will be given on 23th Day of October, 2023.

Each team will have a team code.

Disclosure of identity of the parent college/institution/university shall be made only in the registration form. Disclosure at any other point of time during the competition shall be liable for penalty which includes disqualification.

8. DRESS CODE:

1. Female participants are required to wear either a full suit comprising of a black formal blazer and trousers, full sleeved white shirts or white kurta, black bottom wear along with black blazer/over coat with formal foot wear.
2. Male participants are required to wear a full suit comprising of a black formal blazer and trousers, full sleeved white shirts, any color tie and formal foot wear.
3. Participating teams not following the dress code shall be disqualified.

9. RULES REGARDING MOOT MEMORIAL:

No Moot Memorial is required for the competition.

A) TRIAL COURT GUIDELINES:

. Teams are required to prepare their cases respectively from each side i.e. from the side of Accused and from the side of Respondent as well.

.Teams shall have to make appropriate applications throughout the trial as and when required. Eg. Purnis or any other application supporting your case as per the Courts format

B) FORMAT OF APPLICATION

Teams shall get application as prescribed as per the Courts format by way of print or hand written at the time of the trial or in advance printed format, liberty is given to the teams as per their case and convenience. (Refer Exhibit 4)

C) CASE LAWS

Teams referring to any case laws during the trial shall produce one copy to the Judge and one copy to the other party with ratios marked

D) Teams being for the defence need to submit a Vakalatnama

E) Teams are required to adhere to the ACTUAL COURT ETTIQUETTES & PRACTISE/ CONDUCT. No contempt shall be tolerated.

*PRELIMINARY ROUND

In the Preliminary Round, the teams shall be given the opportunity to argue from both the sides (Round 1 and Round 2)

Brief Intro of case: 2 mins each team

Examination in chief: 8 mins each Witness

Cross Examination: 12 mins each Witness

Final Argument: 15 mins for each team

The teams shall be chosen on the basis of their accumulated score in Round 1 and Round 2.

On the basis of score, eight teams shall be selected for Semi Finals Round.

*SEMI FINAL ROUND:

In the Semi Finals the decision shall be on the basis on 'knockout' (The team shall be given the opportunity to argue from one side as per the draw of lots)

Brief Intro of case: 2 mins each team

Examination in chief: 8 mins each Witness

Cross Examination: 12 mins each Witness

Final Argument: 15 mins for each team

On the basis of score, two teams shall be selected for Final Round.

§ FINAL ROUND:

Each team shall be allotted Prosecution and Defense
as per the draw of lots

Brief Intro of case: 5 mins each team

Examination in chief: 10 mins each Witness

Cross Examination: 15 mins each Witness

Final Argument: 20 mins for each team

11) SCHEDULE

Date	Event	Time
26th October,2023	Day 1	
	Opening Ceremony& Registration	03:00 pm
	Draw of Lots & High Tea	05:00 pm
27th October,2023	Day 2	
	Reporting Time	08:00 am
	Breakfast	08:00 am
	Preliminary Round No.1	09:00 am
	Lunch time	12:00 pm
	Preliminary Round No.2	02:00 pm
	High Tea	04:30 pm
	Qualification Announcement + Draw of Lots	05:00 pm
28th October,2023	Day 3	
	Reporting Time	08:00 am
	Breakfast	08:00 am
	Semi Final Round No.1	09:00 am
	Lunch time	12:00 pm
	Final Round	02:00 pm
	High Tea	04:30 pm
	Award Ceremony	05:00 pm

12. IMPORTANT DATES:

The 1st oriental college of law State Moot Court Competition shall be held from 26th to 28th October, 2023.

Last date of registration	20 October 2023
Last date of clarification	23 October 2023
Team Codes Allotment	23 October 2023

14. Prizes:

Prizes;

Winning team: Rs 10,000+ certificate and award

Runner up: Rs 7,000 + certificate and award

Best speaker: Rs.5,000 + certificate and award

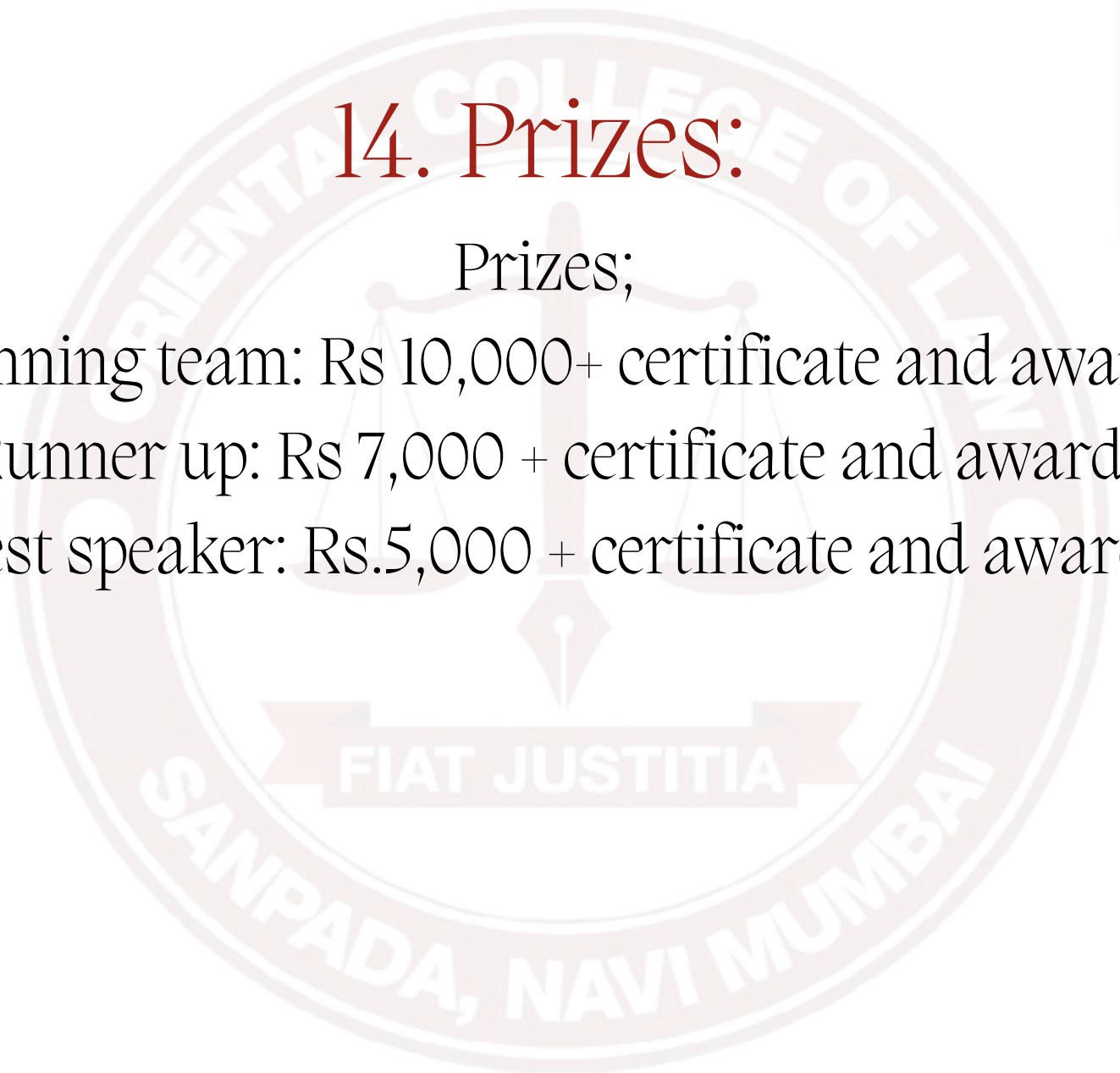

ORIENTAL COLLEGE OF LAW
Presents VAKALAT
INTER COLLEGE MOOT COURT COMPETITION 2023

REGISTRATION FORM

(To Be Filled in Block Letters)
(To be scanned and attached in the Google form)

NAME OF THE INSTITUTION: _____

ADDRESS: _____

CONTACT NO: _____

EMAIL: _____

CONTACT PERSON

(PREFERABLY FACULTY -IN-CHARGE FOR THE MOOT COURT OF
RESPECTIVE INSTITUTION)

NAME: _____

DESIGNATION: _____

CONTACT NO: _____

EMAIL: _____

TEAM DETAILS

SPEAKER 1

FULL NAME: _____

SEMESTER: _____

GENDER: _____

CONTACT NO: _____

EMAIL: _____

Please Paste a
recent
Photograph

SPEAKER 2

FULL NAME: _____

SEMESTER: _____

GENDER: _____

CONTACT NO: _____

EMAIL: _____

Please Paste a
recent
Photograph

WITNESS 1

FULL NAME: _____

SEMESTER: _____

GENDER: _____

CONTACT NO: _____

EMAIL: _____

Please Paste a
recent
Photograph

WITNESS 2

FULL NAME: _____

SEMESTER: _____

GENDER: _____

CONTACT NO: _____

EMAIL: _____

Please Paste a
recent
Photograph

BANK DETAILS

Transaction ID: _____

BANK: _____

BRANCH: _____

DATE: _____

DETAILS OF THE HEAD OF THE INSTITUTION

NAME: _____

EMAIL: _____

CONTACT NO: _____

SIGNATURE: _____

SEAL OF THE INSTITUTION:

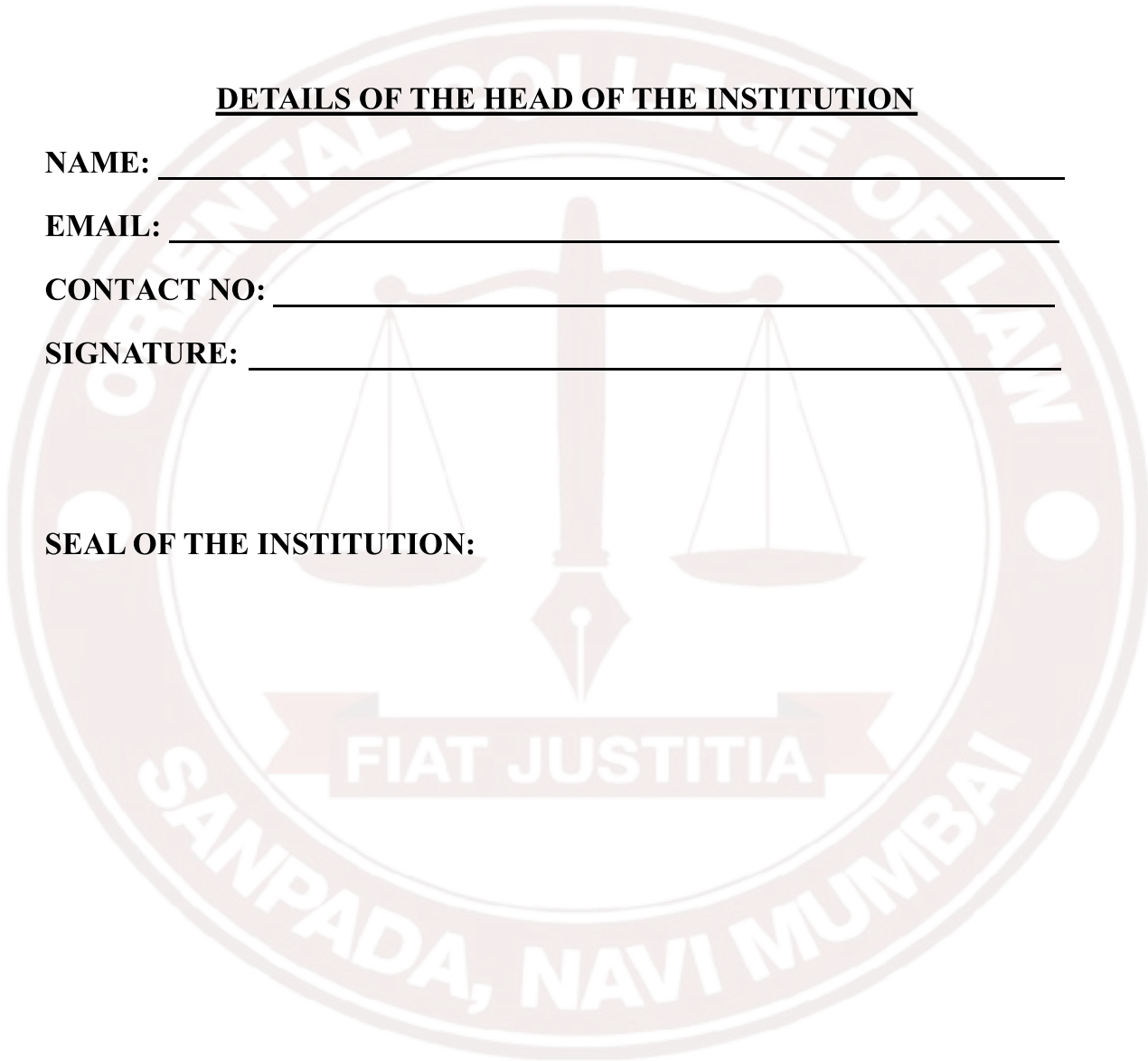

ORIENTAL COLLEGE OF LAW
Presents VAKALAT
INTER COLLEGE MOOT COURT COMPETITION 2023

APPROVAL LETTER / UNDERTAKING

- 1) We hereby state that our participation complies with the rules and regulations of the competition
- 2) We certify that the materials which are being /will be submitted are prepared by us and indemnify the organizers for any claim or dispute arising out of the further use and exhibition of these materials
- 3) We certify that our college is well aware about our participation.

Name & Address of the participating Institution:

Email Id: _____ Regd Mobile: _____

Name of the participants	Gender	Course	Semester	Signature

Seal & Signature of the Institution

MOOT PROBLEM

**IN THE COURT OF SESSION AT GREATER MUMBAI
IN
NDPS SPECIAL CASE No. 345 OF 2021**

Lakhan Singh & Anr

...Accused

V/s

State of Maharashtra

Through Sewree Police Station

...Respondent

LIST OF DOCUMENTS

Sr No.	Particulars	Ex
1.	Chargesheet	Ex-1
2.	Plea recording	Ex-2
3.	Admission/ Denial	Ex-3
4.	Application for Denial	Ex-4
5.	Order by Sessions Judge Gr. Mumbai vide Dt. 10.10.22	Ex-5
6.	Evidence of Dr. Nayar (Pw-1) as per Ex-5	Ex-6
7.	Order by Addl. Chief Metropolitan Magistrate vide dated 24.02.23	Ex-7

**FINAL REPORT FORM
(UNDER SECTION 173 CRPC)**

Ex-1

In the Court of:
Hon'ble Session's Court of Gr Mumbai

Dist	P.S	Year	FIR No.	Date
Mumbai	Sewree	2021	Cr No.245	04/03/2021

Final Report/ Chargesheet No.:

- | | |
|---------|-----------------------|
| i. Act | Section |
| NDPS | 20(b) (ii) (C), 23(c) |
| ii. IPC | 34, 120b |

Type of Final report: Chargesheeted

CHARGESHEET

- If Final Report unoccured: -
- If chargesheeted: Original/ ~~Supplementary~~
- Name of the I.O. : P.I. Jadhav
- Name of the complainant: PSI Tukaram Patil
- Fathers name: Balaji Patil
- Details of Properties / Articles/ Documents recovered / seized investigation relied upon:

Property description	Estimated Value (in Rs)	P. S. Property Registration No.	From Whom/ where recovered/ seized	Disposal
Jute bag containing ganja in polythene bag			House of Lakhan Singh /Room No. 101 Dosa House, Mazgaon	
Jute bag containing ganja in polythene bag			“ ”	
Shirt and Pant of Lakhan Singh			“ ”	
Mobile of Lakhan bearing Imei No. 12345678			“ ”	
Pant and Tee shirt of Raj Sahu			“ ”	
Mobile of Raj bearing Imei No. 1237688			“ ”	

- Particulars of person chargesheeted:

Name: Lakhan Singh
D.O.B.:03.06.2004

Fathers name: Brij Mohan Singh
Occupation: Student

Address: 101, Dosa House, Mazgaon Mumbai

Date of Arrest: 04/03/2021

Date of Release of Bail: -

Date on which forwarded to Court: 05/03/21

Under Acts & Section:

NDPS ACT: 20(b) (ii) (C), 23(c) & IPC 120b, 34

- Particulars of person chargesheeted:

Name: Raj Sahu
D.O.B.:06.02.2004

Fathers name: Suresh Sahu
Occupation: Student

Address: 11, Usha Sadan, Mazgaon, Mumbai

Date of Arrest: 04/03/2021

Date of Release of Bail: -

Date on which forwarded to Court: 05/03/21

Under Acts & Section:

NDPS ACT: 20(b) (ii) (C), 23(c) & IPC 120b, 34

- Particulars of Vehicle Seized if any: -

- List of Witness:

Sr No.	Name of witness	Address	Type of Evidence
1	Shri. Shri Manish Pawar	Gr. Floor, Dosa House	Pancha
2	Dr. Nayar	Banjara Hills, Hyderabad	Forensic Expert/ Witness
3	PSI Tukaram Patil	Sewree Police station, Sewree	Complainant/ Witness
4	P.I. Amit Jadhav	Sewree Police station, Sewree	Investigating Officer/ Witness

- If FIR is false, indicate action to be taken or proposed to be taken u/s 182/211 of IPC: -
- Result of laboratory analysis: Detected Ganja from the seized articles P1,P2, SP1& SP2

- Brief facts of the case:

During refreshment being enjoyed by the complainant, the complainant came across Accused no.1. The said person had a small packet of ganja in his pocket, which fell down when he was heading towards the wash basin of Café Gulzar. Upon this the accused no.1 fled and the complainant began to follow him. Upon reaching at the crime spot the complainant informed PI Jadhav of the same. Upon the arrival of the PI a raid was conducted in 101 Dosa House in the presence of the Pancha Shri Manish Pawar and seized nearly 10.2kg (10kg & 200gms) of ganja each wrapped in a polythene bag from 2 jute bags respectively. Subsequent to which FIR came to be registered with Sewree Police Station.

- Chargesheet:

The Hon'ble Sessions Court of Gr. Mumbai within whose jurisdiction the present crime has occurred is being presented with the following case.

Dated 04.03.21 at about 6.20pm the complainant was enjoying refreshments at café Gulzar, Mazgaon. The accused no. 1 was sitting on the opposite table of the complainant. While the accused was heading towards the basin his packet containing Ganja fell down. Owing to this the accused got scared, picked up the packet and fled on his bike MH-01-AA-2345. Complainant began to follow him, subsequent to the incident. The accused entered one Dosa House bldg. The

complainant monitored the movement and accordingly informed the PI Amit Jadhav. Upon the arrival of the PI a raid was conducted in 101 Dosa House in the presence of the Pancha Shri Manish Pawar, Accuse No. 1 Lakhan Singh and Raj Sahu and seized nearly 10.2kg (10kg & 200gms) each ganja wrapped in a polythene bag from 2 jute bags respectively. Subsequent to which FIR came to be registered with Sewree Police Station. The bags of Ganja were seized from the house of the Accused No.1, while the accused No.2 Raj Sahu was present at the spot. The accused no.1 is into drug trade and was informed by one Aneez to keep the bag in his house. The bag was handed over to the accused no. 1 by one unknown individual, who delivered the same in the morning at 4.00 am on 04.03.21. However Aneez, unknown person are absconding and they shall be chargesheeted separately in a separate CR for their role in this offence. The accused no. 2 was seen in the house of the accused no. 1 and is believed to have conspired the whole crime with common intention. Without causing any delay in trial the Ld. I.O. is filing the present chargesheet against Accused No. 1 Lakhan Singh and Accused No. 2 RajSahu u/s 20(b) (ii) (C), 23(c) of NDPS Act & 120b, 34 of IPC before This Hon'ble Court.

Sd/-
Shri. Vivek Tiwari
03/09/21
Senior Inspector of Police In Charge
Sewree Police Station

Sd/-
Shri. Amit Jadhav
Police Inspector
03/09/21
Sewree Police Station

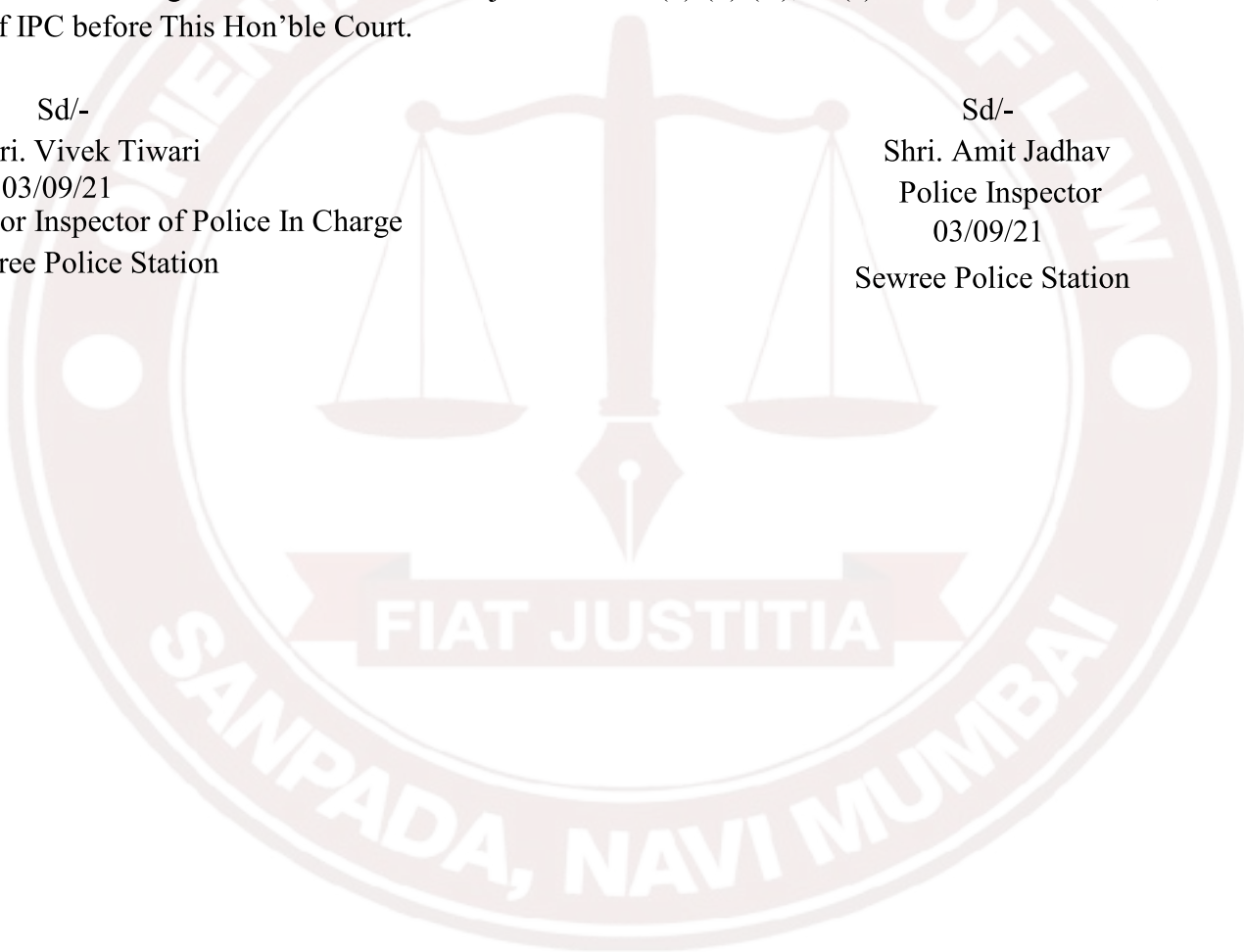

FIRST INFORMATION REPORT
(UNDER SECTION 154 CR.P.C.)

1. District: Mumbai

P.S: Sewree

Year: 2021

FIR No. : 245

Date & time of FIR: 04.03.21 at 07.15pm

2.

Sr No.	ACT	Section
1	NDPS	20(b)(ii)(C)
2	NDPS	23(c)
3	IPC	120b
4	IPC	R/w 34

3. (a) Information Received at P.S.:

Date: 04.03.21

Time: 07.15 pm

(b) General Diary Reference:

Entry No.:57

Date & Time: 04.03.21@ 07.15 pm

4. Type of Information: Oral

Name of Officer: P.I. Amit Jadhav

5. Complainant Information:

a) Name: Tukaram Balaji Patil

b) Fathers/Husband's Name: Balaji Patil

c) Date of Birth & Year:10.01.1973

d) Nationality: Indian

e) Passport No.: -

f) Date of Issue: -

Place of Issue: -

g) ID Details(Voter Card, Ration Card, Driving License)

Sr No.	Id Type	ID No.
1	Driving License	Abcd

h) Occupation: Service

i) Address:

Sr No.	Address Type	Address
1	Residential	21, Building No. -2, Tagore Street, Vikhroli, Mumbai.
2	Local Address	Sewree Police station, Sewree Mumbai

j) Phone No.: 123456789

6. Details of known/suspected/ unknown accused with full particulars:
Accused More Than

Sr No.	Name	Relative's Name	Permanent Address
1	Lakhna Singh	Brij Mohan Singh	101, Dosa House, Mazgaon Mumbai
2	Raj Sahu	Suresh Sahu	11, Usha Sadan, Mazgaon, Mumbai

- 7.

Sr No.	Property Category	Property Type	Particulars of Property	Value In Rs.
1	Bag of Ganja seized in Qty 2	Movable property	Jute Bag	210,000/-

8. Total Value of Property in Rs.: Two Lakhs & Ten Thousand only/-

9. Inquest Report/U. D. Case No. if any,

Sr No.	UIDB No.

10. First Information Contents:

On 4st day of March, 2021 in the evening PSI Tukaram Patil age 50 years old, an adult, Indian, Inhabitant, bearing buckle no. 45321/1994 presently serving at Sewree Police Station, Sewree, Mumbai-11, as a Police sub Inspector, was in a restaurant named Café Gulzar for refreshments, near Rosary High School, Mazgaon. At about 6.20pm the complainant came across an individual wearing black bush shirt and blue jean. The said individual was on opposite table, while he heading towards the basin a packet of him fell down, coincidentally his eyes met the complainant's eyes and no sooner he picked it up than he immediately got out of the café and rode his bike bearing no MH-01-AA-2345. Seeing this, the complainant found something fishy and began to follow him. The same was informed to P.I. Jadhav of Sewree Police station by phone after monitoring the situation at Dosa house, where the individual entered. Upon arrival of P.I. Jadhav, the complainant along with the watchman and PI Jadhav entered the room on 1st floor (101) and conducted search, where ganja was recovered weighing all together at 20.4 kg (20kg & 400gms) in the presence of the 2 accused Lakhna Singh and Raj Sahu. Subsequent to which the following CR was registered.

The above contents have been read before me in Marathi and my known language, which I understand to be true and correct to the best of my knowledge.

Sd/-
Mr. Tukaram Balaji Patil
04.03.21

Sd/
P.I. Amit Jadhav
04.03.21

STATEMENT

I, Mr. Tukaram Balaji Patil, age 50 years old, an adult, Indian, Inhabitant, bearing buckle no. 45321/1994 presently serving at Sewree Police Station, Sewree, Mumbai-11, as a Police sub Inspector.

On 4st day of March, 2021 in café Gulzar, next to the Rosary High School, I was sitting for refreshment. No sooner than I placed my order for tea, one individual possessing an athlete body, standing tall at 5.4ft, wearing a black bush shirt and blue jean, at about 6.20 pm in the evening came in Café Gulzar and sat on the table ahead of me. I was facing the only main entrance of the hotel; the individual was on the table in vertical tandem of my table, with his back facing me. Upon his arrival he got a phone call, the call lasted for a couple of minutes, the only thing which I could hear was “Ji.Ji...Ji, finally at one juncture the individual said “ ji ghaas hai ghar pe”. The last sentence made me questionable ghaas & ghar. While wondering the same, the individual got up to head towards the basin on our east side, when a transparent polythene pouch bag fell down from his pocket. Prima facie it appeared to be like tobacco, which he immediately picked it up. As his eyes met mine he swiftly washed his hands and left the premise. I quickly evaluated the incident and went behind him, as I reached out of the hotel I saw him leaving on a black bike bearing no. MH-01-AA-2345. I immediately began to follow him on my bike. Following the individual I reached at a building named Dosa House CHS LTD, opposite to Mazgaon Dock Ship Yard Ltd., the individual rode his bike in the premise of the building. I stopped there to monitor further movements and alongside immediately called my senior Mr. Amit Jadhav, P.I. at the incident spot by way of phone call. Mr. Jadhav reached at the spot within 2 minutes. Upon his arrival we proceeded further, we were stopped by the watchman and were asked to make entry in the register placed on the table next to the lift; subsequently an entry was made at 6.41pm. We asked the watchman about the individual, who happened to be Mr. Lakhan Singh further took the watch man with us to his room, which was on 1st floor. As we rang the bell Lakhan came out and attended us, from the door we could see he was inside with another person. We imparted our intention to frisk Lakhan and also offered our search to him thrice, all the time he refused. Owing this in the presence of the watchman we frisked Lakhan and found nothing. Further we called the other individual ahead for search, offered him our search which he refused, finally upon searching the other individual we found nothing.

Post this we stepped in the house which was a 120 sqft room. Upon searching for a few minutes in the house, in a cabinet as tall as 4ft with brown glossy finish, on the right hand side of the door we found two big jute bag each had a polythene bag with a substance like Ganja. On having a closer look we found ganja, each parcel appeared to weigh somewhere about 8 -9kg. Immediately we made Sewree Police Station cognizant and registered a FIR against the two accused.

The above contents have been read before me in Marathi and my known language which I understand to be true and correct to the best of my knowledge.

Sd/-
Mr. Tukaram Balaji Patil
04.03.21

Sd/-
P.I. Amit Jadhav
04.03.21

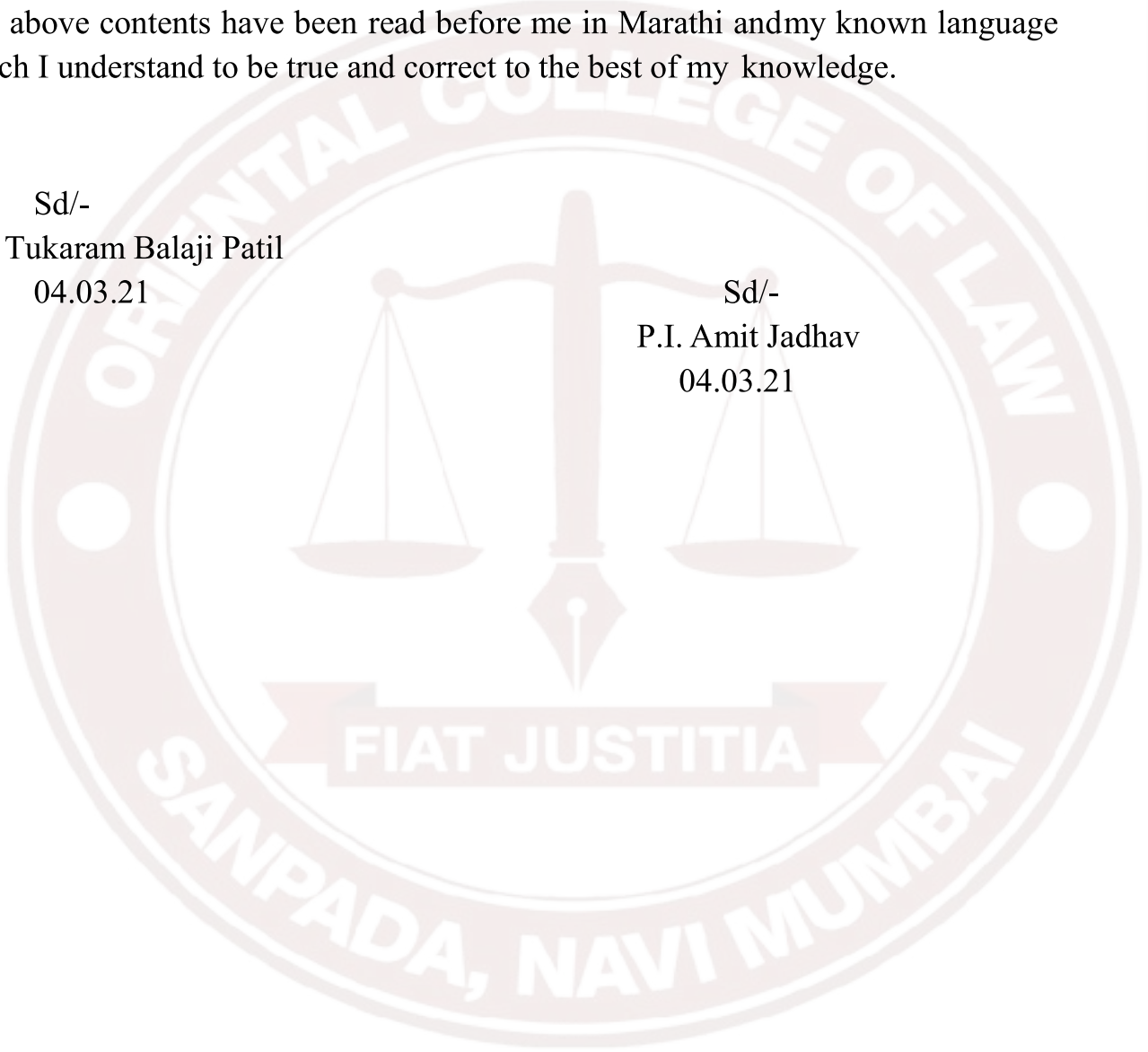

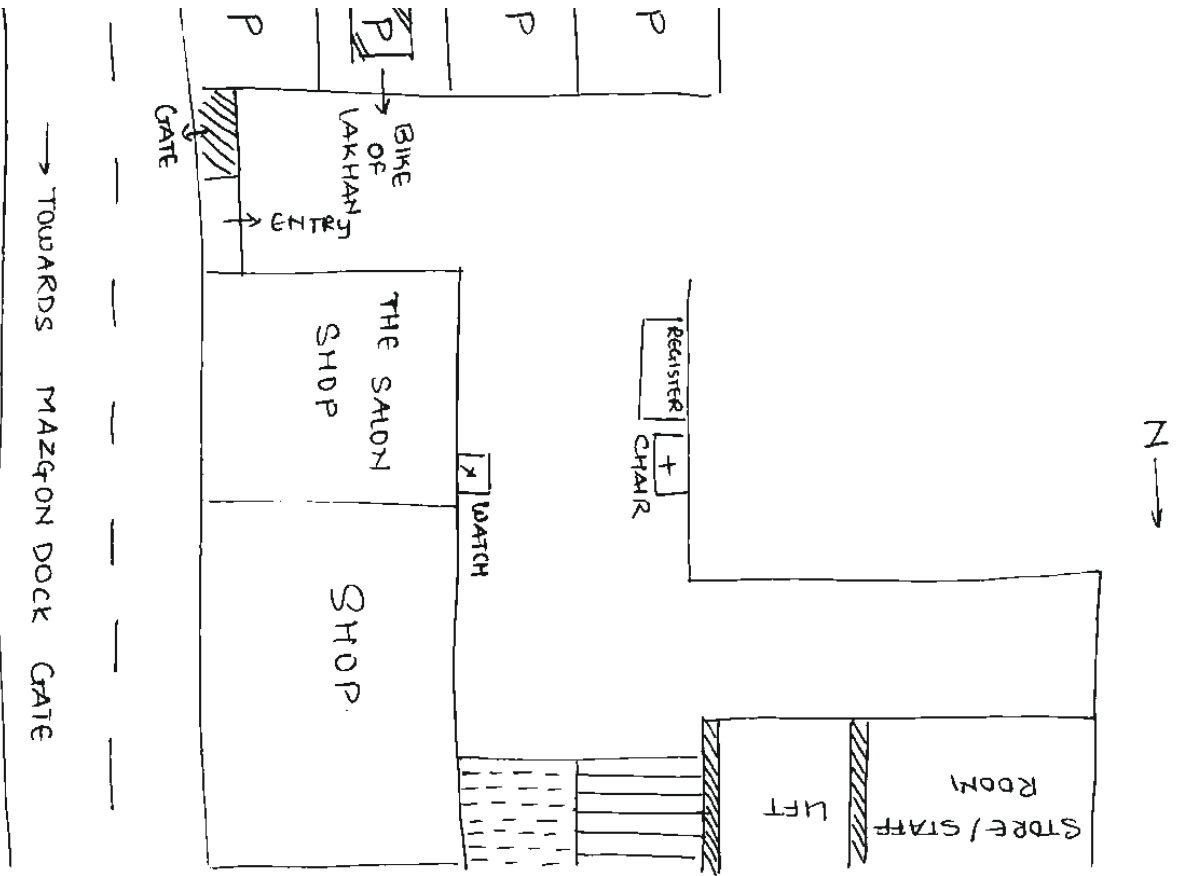

Sd/-
Manish Purohit
(Pancha)
4/3/21

Sd/-
Amit Jadhav
(I.O)
4/3/21

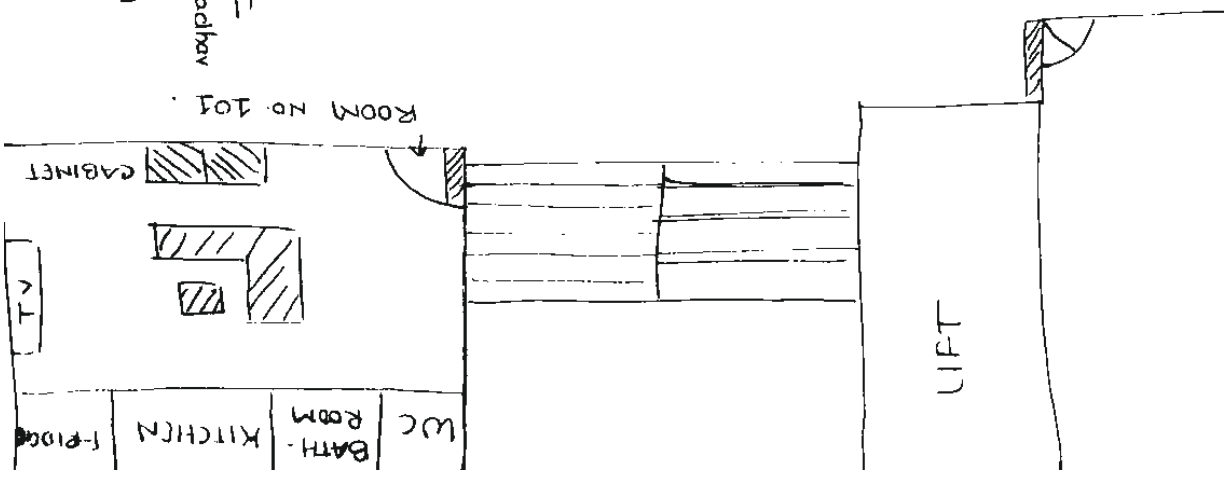

ANG-JADTI PANCHNAMA

Name of the Pancha: Shri Manish Pawar

Age 48, an adult, Indian, Inhabitant,
having address at Gr. Flr. Dosa House
CHS LTD., Mazgaon, Mumbai.

The above mentioned pancha was found in the building premise itself. The pancha is serving as a watchman for the said society for past 14 years. The pancha is a native resident of Satara and is staying in the society in a room allotted by the society members.

The said incident took place in the evening, when two individual identifying themselves as police came in the society. The pancha being near the lift stopped them and asked them “where are they heading”, to whom they asked about the individual who just entered on bike. The pancha stated him to be Lakhan who lives in room no. 101, the 2 asked pancha to come along with them.

Upon reaching Lakhan’s house the police individuals identified themselves as police and said they would like to frisk Lakhan. The police individuals offered Lakhan their search thrice, but Lakhan did not utter a word, finally PSI Patil frisked the body of the accused Lakhan. Patil frisked him head to toe, in the shirt pocket of bush shirt followed by jean pant, wallet, socks but found nothing.

Patil then searched the other individual named Raj Sahu, who was wearing black tee shirt and blue jean. Patil frisked the body of the accused Raj. Patil frisked him head to toe, in the tee shirt pocket followed by jean pant, wallet, socks but found nothing. The said search was done in the presence of the panch near the door of Lakhan Singh’s house at about 6.42 pm in the evening. Following which they stepped in the house.

The above contents have been read before me in Marathi and my known language which I understand to be true and correct to the best of my knowledge.

Sd/-

Shri Manish Pawar
04.03.2021

Sd/

P.I. Amit Jadhav
04.03.21

JAPTI PANCHNAMA

Name of the Pancha: Shri Manish Pawar

Age 48, an adult, Indian, Inhabitant,
having address at Gr. Flr. Dosa House
CHS LTD., Mazgaon, Mumbai.

The above mentioned pancha was found in the building premise itself. The pancha is serving as a watchman for the said society for past 14 years. The pancha is a native resident of Satara and is staying in the society in a room allotted by the society members.

The said incident took place in the evening, when two individual identifying themselves as police came in the society. The pancha being near the lift stopped them and asked them "where are they heading", to whom they asked about the individual who just entered on bike. The pancha stated him to be Lakhan who lives in room no. 101, the 2 asked the pancha to come along with them. Upon reaching the house of Lakhan both the accused were searched and frisked. The police individuals entered in the house, upon searching for a few minutes, in a cabinet as tall as 4ft with brown glossy finish, on the right hand side of the door they found two big jute bag khakee colour, each had a polythene bag with a substance like Ganja. On having a closer look we found ganja, each parcel appeared to weigh somewhere about 8-9kg. After the arrival of police team each parcel was weighed on a digital weighing scale, where it amounted to be 10.2 kg each (10kg & 200gms). Both the parcels were cut open and an equal amount was drawn of about 25 grams each. The parent bags were then seized and sealed in a brown envelope with a seal on it, each parent bag was named as P1 and P2 respectively. The sample bags were named as SP1 (sample of P1) and SP2 (sample of P2), seized and sealed in a brown envelope. All the sample i.e. P1, P2, SP1 and SP2 were signed by the two accused, pancha and PI Jadhav followed by the date and time 6.48PM. Further the clothes of the accused were also seized in a polythene bag i.e. their shirt, jean and tee shirt, jean, the same were sealed and signed by the PI and accused and pancha. The said seizure panchanama was recorded and conducted in the presence of the pancha. The above contents have been read before me in Marathi and my known language which I understand to be true and correct to the best of my knowledge.

Sd/-

Shri Manish Pawar

04.03.21

Sd/-

P.I. Amit Jadhav

04.03.21

ARREST PANCHNAMA

Name of the Pancha: Shri Manish Pawar

Age 48, an adult, Indian, Inhabitant,
having address at Gr. Flr. Dosa House CHS LTD., Mazgaon,
Mumbai

The above mentioned pancha was found in the building premise itself. The pancha is serving as a watchman for the said society for past 14 years. The pancha is a native resident of Satara and is staying in the society in a room allotted by the society members.

The said incident took place in the evening, when two individual identifying themselves as police came in the society. The pancha being near the lift stopped them and asked them "where are they heading", to whom they asked about the individual who just entered on bike. The pancha stated him to be Lakhan who lives in room no. 101, the 2 asked the pancha to come along with them.

Upon going at their door the two accused were frisked and while searching the house 2 packets of Ganja were found in the house. Subsequent to which the 2 accused were arrested for the same offence. Further their family members/ acquaintances were also informed of the same.

The above contents have been read before me in Marathi and my known language which I understand to be true and correct to the best of my knowledge.

Sd/-
Shri Manish Pawar
04.03.21

Sd/-
P.I. Amit Jadhav
04.03.21

SPOT PANCHANAMA

Name of the Pancha: Shri Manish Pawar

Age 48, an adult, Indian, Inhabitant,
having address at Gr. Flr. Dosa House CHS LTD., Mazgaon,
Mumbai

The above mentioned pancha was found in the building premise itself. The pancha is serving as a watchman for the said society for past 14 years. The pancha is a native resident of Satara and is staying in the society in a room allotted by the society members.

The incident took place in the evening; the 2 police individual took charge of the situation. Frisked the 2 accused at the entrance of their room, which was admeasuring 120 sqft. The search and frisk of the accused was made post the officials offering them their personal searches. However that was denied, as a result the officials proceeded further and conducted a search for a few minutes Soon from the cabinet as tall as 4ft with brown glossy finish on the right side of the door upon entry, the said drug bag of jute was seized. There were 2 bags of jute with ganja contained in a polythene bag. Post the seizure of the drug bag police station was informed and accordingly FIR came to be registered. The articles were drawn as samples in my presence and so were sealed in brown envelope with the signs of me accused and the I.O. subsequently following panchanamas were drawn in my presence and the same was conducted before me.

The above contents have been read before me in Marathi and my known language which I understand to be true and correct to the best of my knowledge

Sd/-
Shri Manish Pawar
04.03.21

Sd/-
P.I. Amit Jadhav
04.03.21

Amit Jadhav, P.I.
Buckle No. -3345/ 2008
Sewree Police Station,
Sewree, Mumbai.
Date: 04.03.21
Time: 6:40p.m.

To,
DCP Port Zone,
Ballard Pier,
Ballard Estate,
Mumbai.

Sub.:- INTIMATION & COMPLIANCE U/S 42 OF NDPS ACT .

Sir,

I Mr. Amit Jadhav, P.I. stationed at above mentioned police station, received a phone call from my colleague Mr. Patil pursuant to a drug trade or drug possession. No sooner I gained cognizance, than I rushed to the spot. Owing to the presence of only two of us and not affording any opportunity of losing the accused along with the articles to be seized if any, we proceeded further as prescribed in law for search, seizure and arrest.

Sd/-
P.I. Amit Jadhav
04.03.21

Received by DCP Office on: 05.04.21 at 07.00pm

Amit Jadhav, P.I.
Buckle No. -3345/ 2008
Sewree Police Station,
Sewree, Mumbai.
Date: 04.03.21
Time: 6:40p.m.

To,
DCP Port Zone,
Ballard Pier,
Ballard Estate,
Mumbai.

Sub.:- INTIMATION & COMPLIANCE U/S 50 OF NDPS ACT.

Sir,

I Mr. Amit Jadhav, P.I. stationed at above mentioned police station, received a phone call from my colleague Mr. Patil pursuant to a drug trade or drug possession. No sooner I gained cognizance, than I rushed to the spot. Owing to the presence of only two of us and not affording any opportunity of losing the accused along with the articles to be seized if any, we proceeded further as prescribed in law for search, seizure and arrest.

Sd/-

P.I. Amit Jadhav

04.03.21

Received by DCP Office on: 05.04.21 at 07.00pm

EXAMINATION REPORT

M.L. Case No.-Cy/ 518/ 2021

To,
Senior Inspector,
Sewree Police Station,
Sewree, Mumbai, Maharashtra.

1. Ref No.- 4933/2021
2. No. of Exhibit Received: 4(P1, P2, SP1 and SP2)
3. Cr No.- 245/2021 U/s:- u/s 20(b)(ii)(C), 23(c) of NDPS Act
& 120b, 34 of IPC
4. Mode of receipt- ASI- 21452 Date of receipt: 09.03.21

Condition of Envelope, Seal and Parcel: 4 seal parcel sealed and intact as sent

Sr No.	Ex No.	Description of item
1	P1	Ganja Weight prior test: 10.175 gms Ganja Weight after test: 10.175 gms
2	P2	Ganja Weight prior test: 10.175 gms Ganja Weight after test: 10.175 gms
3	SP1	Ganja Weight prior test: 25 gms Ganja Weight after test: 25 gms
4	Sp2	Ganja Weight prior test: 25 gms Ganja Weight after test: 25 gms

Scientific name: Tetrahydrocannabinol (THC)

Conclusion:

Article in sample were found with dried flower, fruit, leaves and stem. The extract of P1, P2, SP1 & SP2 is identified as Marijuana or Ganja with active components in natural form of Tetrahydrocannabinol (THC).

Date: 24.07.21
Place Hyderabad

Sd/-
Dr. Nayar
Forensic Laboratory
Hyderabad

STATEMENT

I, Dr Nayar a practicing forensic expert and having office address as Directorate of Forensic Science Laboratory, Hyderabad, Telangana.

I got cognizant of the said crime, post the registration of Cr No.245 of 2021 by way of mobile phone by the I.O. accordingly the seized articles were brought to the laboratory by way of police escorts on 09.03.21. The articles were received to me along with a request letter to conduct forensic analysis of the said articles. The articles which I received were in a brown envelope bearing a seal followed with a few signs namely of the pancha, accused and the I.O. upon breaking the seal, inside the envelope I found 4 packets namely P1, P2, SP1 and SP2. Prima facie they appeared to be a narcotic substance THC and were found with dried flower, fruiting top, leaves and stem. Each of the parent packets weighed packets weighed 10.175kg (10kg & 175gms) prior test and each of the sample packets weighed 25 grams. A sample of 5grams was drawn from each of the 4 packets. The potency test was done by using methods like gas chromatography and high performance liquid chromatography. Upon the test an evaluation conclusion was drawn that the Tetrahydrocannabinol (THC) was present with nearly quarter part of contaminants

Based on the analysis the present research was drawn and post conclusion was sent to the I.O. for further proceedings. The seized articles were returned back to the police authority for further disposal.

The above contents have been read before me, in Hindi and the same I believe to be true and correct to my believe.

Sd/-

Dr. Nayar
04.08.2021

Sd/-

P.I. Amit Jadhav
04.08.21

Ex-2

IN THE COURT OF SESSION AT GREATER MUMBAI
IN
NDPS SPECIAL CASE No. 345 OF 2021

Lakhan Singh & Anr ...Accused
V/s
State of Maharashtra
Through Sewree Police Station ...Respondent

PLEA RECORDING OF ACCUSED No. 1 U/S 251 OF CRPC

Name of the Accused: Lakhan Singh

Age: 19 years

Occupation: Not Working

Inhabitant of: Arthur Road Jail

Ques. Do you wish to plead guilty of offences u/s 20 (b) (ii) (C) & 23(c) of NDPS Act and u/s 120b, r/w 34 of IPC?

Ans. No, I don't plead guilty

The above plea is recorded before me, the same is read and explained to the accused in Marathi with all charges charged against him, Pursuant to which the Accused no. 1 does not plead guilty and wished to be tried and prosecuted. Further it contains a full and true account the statement made by me.

Date: 20.10.21

Sd/-

B. N. Sakpal
Spl. Judge Under NDPS Act
Gr. Mumbai
20.10.21

IN THE COURT OF SESSION AT GREATER MUMBAI

IN

NDPS SPECIAL CASE No. 345 OF 2021

Lakhan Singh & Anr

...Accused

V/s

State of Maharashtra

Through Sewree Police Station

...Respondent

PLEA RECORDING OF ACCUSED No. 2 U/S 251 OF CRPC

Name of the Accused: Raj Sahu

Age: 19 years

Occupation: Not Working

Inhabitant of: Arthur Road Jail

Ques. Do you wish to plead guilty of offences u/s 20 (b) (ii) (C) & 23(c) of NDPS Act and u/s 120b, r/w 34 of IPC?

Ans. No, I don't plead guilty

The above plea is recorded before me, the same is read and explained to the accused in Marathi with all charges charged against him, Pursuant to which the Accused no. 1 does not plead guilty and wished to be tried and prosecuted. Further it contains a full and true account the statement made by me.

Date: 20.10.21

Sd/-

B. N. Sakpal

Spl. Judge Under NDPS Act

Gr. Mumbai

20.10.21

IN THE COURT OF SESSION AT GREATER MUMBAI
IN
NDPS SPECIAL CASE No. 345 OF 2022

Lakhan Singh & Anr

...Accused

V/s

State of Maharashtra

Through Sewree Police Station

...Respondent

MAY IT PLEASE YOU HONOUR

The defense is called upon to either admit or deny genuineness of the documents enlisted herein. In order to be listed as exhibit in the court as contemplated u/s 294 of CRPC.

Sr No	Particulars	Original/Xerox	Prepared by whom	Name of attesting witness
1	FIR Copy	Original	PI Jadhav	PSI Patil/ PI Jadhav
2	Chargesheet	“	“	P.I. Jadhav(PW-4)
3	Statement of the Complainant	“	“	PSI T. Patil(PW-3)
4	Panchnama	“	“	Shri Manish Pawar(PW-2)
5	Ang-Jadti Panchnama	“	“	“
6	Japti Panchnama	“	“	“
7	Spot Panchnam	“	“	“
8	Arrest Panchnama	“	“	“
9	Forensic report	“	Dr. Nayar	Dr. Nayar(PW-1)
10	Statement Dr.	“	PI Jadhav	“

Date: 05.03.22

Seal/-

Sewree Police Station

IN THE COURT OF SESSION AT GREATER MUMBAI

IN

NDPS SPECIAL CASE No. 345 OF 2022

Lakhan Singh & Anr

...Accused

V/s

State of Maharashtra

Through Sewree Police Station

...Respondent

**APPLICATION FOR DENIAL OF
THE ENLISTED DOCUMENTS
GENUINNESS**

MAY IT PLEASE YOU HONOUR:-

The defense does not rely on the genuineness of the list of documents enlisted above and wish to be cross examined, for the ends of justice to meet.

Place Mumbai

Sd/-

Advocate for accused

01.04.22

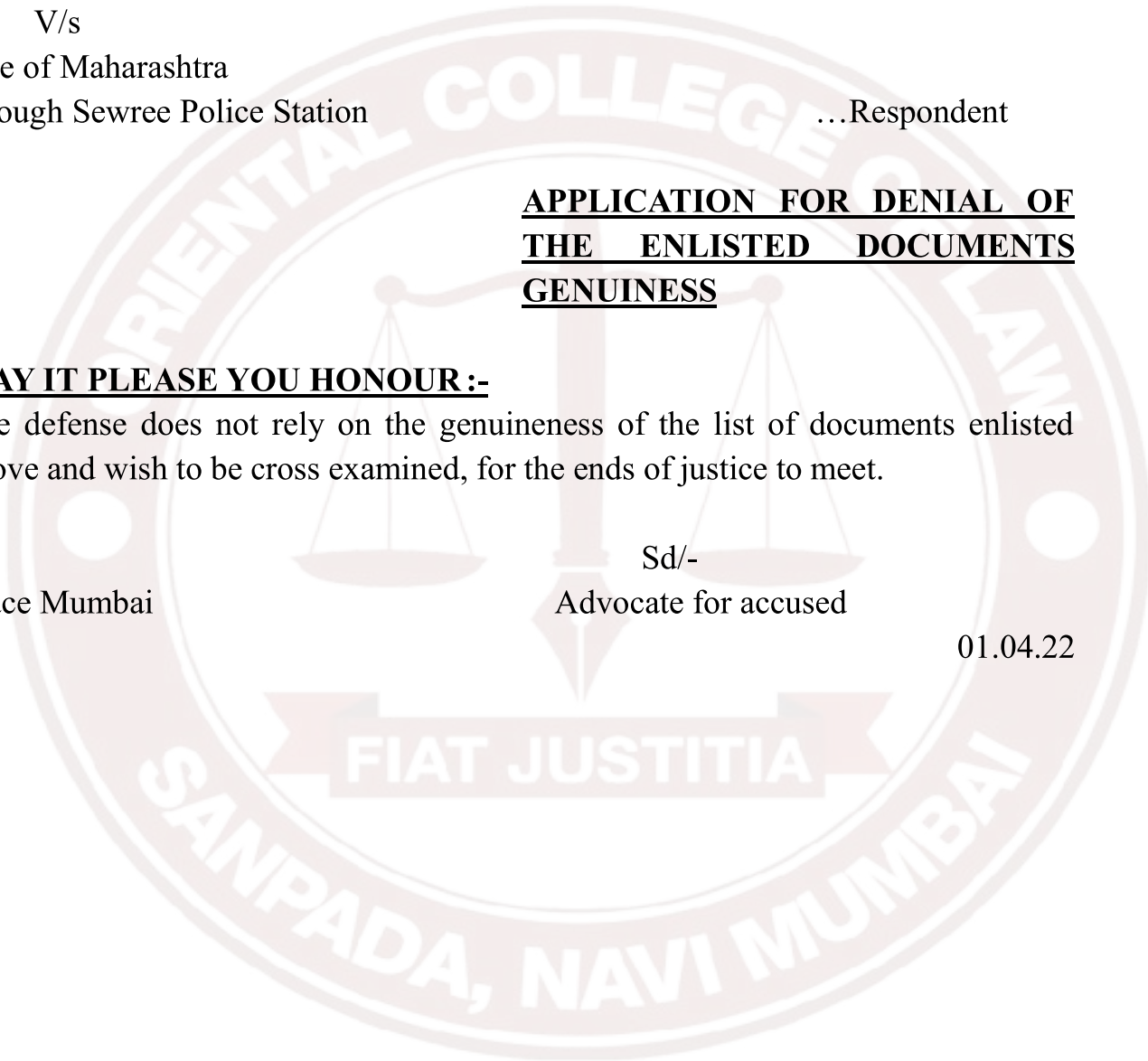

IN THE COURT OF SESSION AT GREATER MUMBAI

IN

NDPS SPECIAL CASE No. 345 OF 2021

Lakhan Singh & Anr

...Accused

V/s

State of Maharashtra

Through Sewree Police Station

...Respondent

Coram: H.H.J. B.N. SAKPAL

Date: 10.10.22

ORDER

P.C:

1. Due to obligatory duty and responsibility the Forensic expert deployed at Hyderabad laboratory was unable to come before this court multiple times to record evidence. Owing to the same the Ld. S.P.P. moved an application for recording the respective evidence before the respective forum in whose jurisdiction the expert is working i.e. Addl. Chief Metropolitan Magistrate, Hyderabad.
2. Having heard the counsel of the accused the court is of the view to commission the Addl. Chief Metropolitan Magistrate, Hyderabad to record the evidence of the forensic expert Dr. Nayar on 20.02.23 at 2.30 pm.
3. The Ld. Forensic expert is directed to be present before the Addl. Chief Metropolitan Magistrate, Hyderabad at the said date and time at priority.

Sd/-

B. N. Sakpal

Spl. Judge Under NDPS Act

Gr. Mumbai

10.10.22

Date:20.02.23

**IN THE COURT OF ADDITIONAL CHIEF
METROPOLITAN MAGISTRATE, HYDERABAD**

IN

NDPS SPECIAL CASE No. 345 OF 2022

(MUMBAI)

DEPOSITION OF WITNESS No FOR THE PROSECUTION

I do on solemn affirmation state that:

My name is : Dr. Nayar
My age is : 35 years of age
My occupation is : Forensic Expert
I m residing at : Banjara hills, Hyderabad, Telangana

Examination in chief by SPP for state:-

1. I have completed my bachelors in Forensic science from Telangana State University and have been working with the said forensic laboratory for past 5 years as Asst. Forensic expert and have recently been promoted to a senior rank.
2. I was informed about the said case by the I.O by way of mobile phone and the accordingly the articles were sent to the lab with a request letter for conducting analysis on the seized article.
3. The seized articles were in 4 packets P1, P2, SP1 and SP2 each of them weighed at 10.175 and 25 grams respectively. The said articles were brought in brown envelope with seal and signs of the accused, pancha and I.O.
4. The said articles were upon prima facie view was identified to be Tetrahydrocannabinol(THC) with dried flower, fruit leaves and stem.
5. Further upon the potency test was done by using methods like gas chromatography and high performance liquid chromatography. Upon the test the evaluation conclusion was drawn that the Tetrahydrocannabinol(THC) was present with nearly quarter part of contaminants
6. The same was concluded in the report drawn vide dated. Yes I shall identify if the report shown to me. Yes the report bears my signature.

Cross Examination by the Defense Counsel:-

1. It shall be true to say that, I am possessing knowledge of Forensic science.
2. It shall be true to say that I do not remember the phone no. of the I.O. as I do not know him in person.
3. It shall be true to say that the said articles were brought to the lab with a request letter. And I shall identify it if shown.
4. It shall be true to say that the articles were in brown bag and were in sealed packets namely P1, P2, SP1, SP2.
5. It shall be true to say that the articles weighed at 10.175 kg(parent bag) and 25grams(sample).
6. It shall be false to say that the samples were tampered.
7. It shall be false to say that gas chromatography and high performance liquid chromatography test are inaccurate.
8. It shall be false to say that the samples and the parent parcel had no Tetrahydrocannabinol(THC) contents.
9. It shall be false to say that everything I deposited is false.

Evidence Closed of the PW /1 for the prosecution.

Sd/-

R.R. REDDY

ADDL. CHIEF METROPOLITAN MAGISTRATE

20.02.23

SANPADA, NAVI MUMBAI
FIAT JUSTITIA

**IN THE COURT OF ADDITIONAL CHIEF
METROPOLITAN MAGISTRATE, HYDERABAD**

IN

**NDPS SPECIAL CASE No. 345 OF 2021
(MUMBAI)**

Lakhan Singh & Anr ...Accused

V/s

State of Maharashtra

Through Sewree Police Station

...Respondent

Coram: **H.H.M. R.R. REDDY**

Date: 24.02.23

ORDER

P.C:

1. Upon the direction of commission of the Ld. Special Court of session at Greater Mumbai vide order dated 10. 10.22 the evidence of the Ld. Forensic Expert has been recorded as prescribed in law in the presence of Adv. K.K. Krishnamurthy for the accused and Add. S.P.P Shri Balkrishnan for the State.
2. The same shall be enclosed in a sealed envelope and transferred to Ld. Special Court of session at Greater Mumbai, CR. No. 44 presided by **H.H.J. B.N.SAKPAL.**
3. The commission hereby stands disposed off

Sd/-

R.R. REDDY

ADDL. CHIEF METROPOLITAN MAGISTRATE

24.02.23

Contact Us

All communication will take place through Email, Whatsapp and phone calls as provided below:

Email : **oclmootcourt@gmail.com**



ocl.mca



orientalcollegeoflaw

1) Chairperson/ Faculty In charge :

ASST PROF. ADV. VINIT PAREEKH

(+91 9619519074)

2) Contact Griveance Team:

DHARNI THAKKAR

(+91 89299 21135)

KRUPESH BHOSALE

(+91 74000 09906)